

EPIGAP Optronik GmbH

Koepenicker Str. 325b
 D-12555 Berlin
 Fon: +49 (0)30 657637 60
 Fax: +49 (0)30 657637 70
 sales@epigap-optronic.de



Data Sheet

Page 1 of 3

Si Avalanche Photodiode

EOAPD-905-1-15

Rev. 01, 2017

Spectral range	Type	Case
visible-near IR	Si	LCC6 SMD

Circular ($\varnothing 500 \mu\text{m}$) 2 mm^2 active area avalanche photodiode optimized sensitivity at 905 nm, housed in a LCC6 SMD package. It is well suited for applications requiring high speed and low noise in visible-near IR applications.

Features:

- > Fast Rise Time
- > Ultra Low Noise
- > Low Capacitance
- > High Gain
- > Optimum Gain M100

Applications:

- > Optical rangefinders
- > High speed optical communications
- > Medical Equipment
- > Bar Code Readers

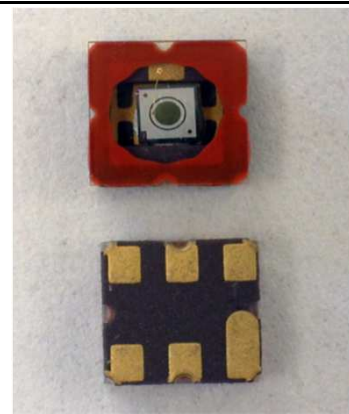

Absolute maximum ratings

Parameters	Symbol	Rating	Unit
Operating temperature range	T_{OPR}	-20...+85	$^{\circ}\text{C}$
Storage temperature range	T_{STG}	-55...+125	$^{\circ}\text{C}$
Power dissipation	P_D	1	mW
Storage temperature range	I_F	1	mA
Operating voltage	V_{OP}	$0.95 \times V_{BR}$	V
Lead soldering temperature*	T_{LS}	260	$^{\circ}\text{C}$

*Time 10 sec max



Electro-optical characteristics:

$T_{amb} = 25^{\circ}\text{C}$, unless otherwise specified

Parameters	Symbol	Min	Typ	Max	Unit	Test conditions
Sensitivity range	λ	400		1100	nm	
Active area	I_{PH}		$\varnothing 500$		μm	
Responsivity	S_{λ}	50	55		A/W	$\Phi_e = 1 \mu\text{W}$, M=100, $\lambda = 905 \text{ nm}$
Rise time	t_R		0.6		ns	f=1 MHz, $R_L = 50 \Omega$, $\lambda = 905 \text{ nm}$
Dark current	I_D	0.1	0.4	1	nA	M=100
Capacitance	C_j		1.2		pF	M=100, 1 MHz
Optimal gain	M		100			
Breakdown voltage	V_{BR}	120		160	V	$I_R = 2 \mu\text{A}$
Temperature coefficient	TKV		0.9		V/K	$T = -40 \dots +85$

We reserve the right to make changes to improve technical design and may do so without further notice. Parameters can vary in different applications. All operating parameters must be validated for each customer application by the customer.

Data Sheet

Si Avalanche Photodiode

EOAPD-905-1-15

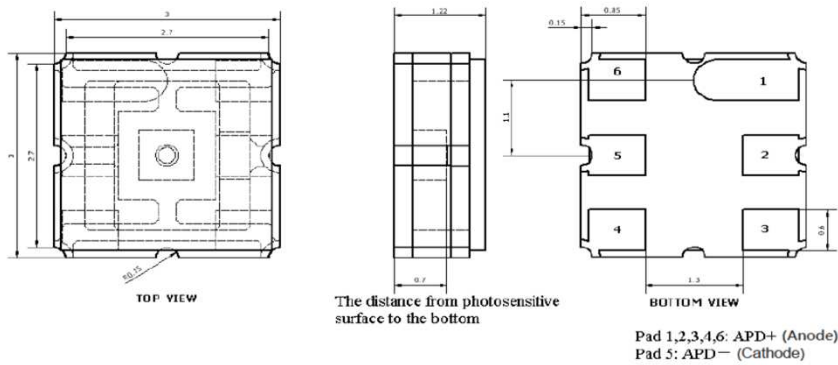

Unit: mm, Tolerance: ±0.2

Package dimensions in mm

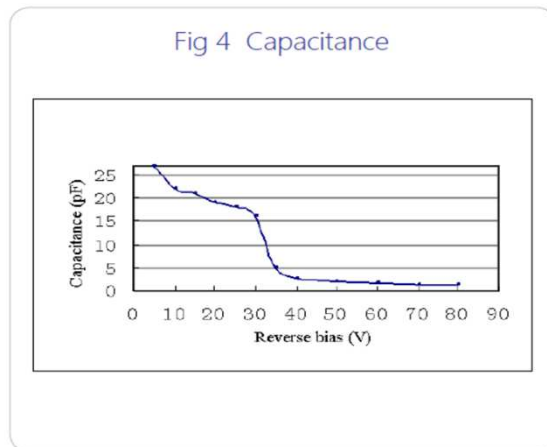
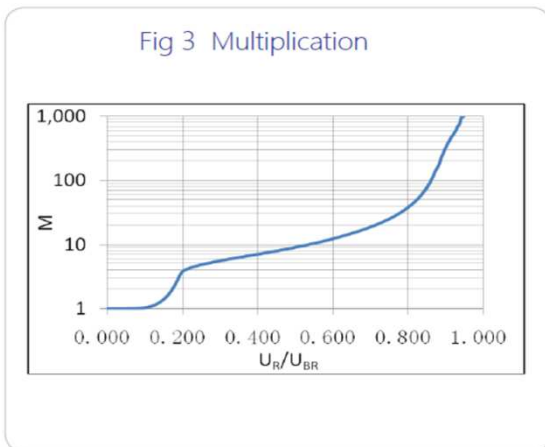
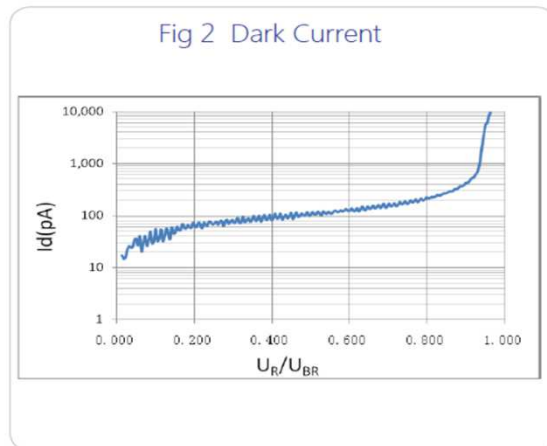
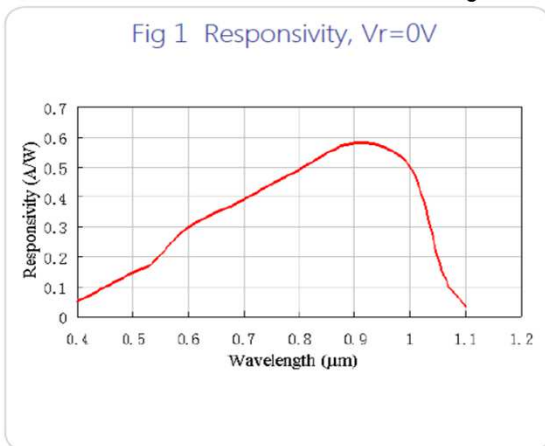

Data Sheet

Si Avalanche Photodiode

EOAPD-905-1-15

Applications Diagram

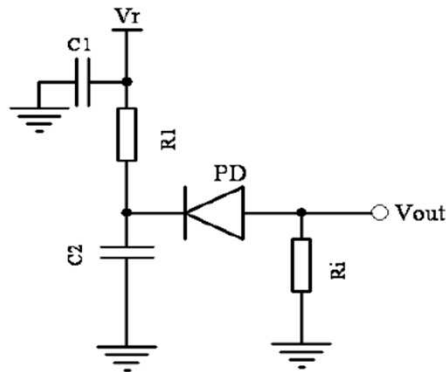

Notes: C1 - Filter capacitor, filter noise from Vr.

C2 - bypass capacitor, the loop to ground for AC signal.

R1 - current-limiting resistor, protect APD from higher voltage.

Ri - sampling resistor, convert the current signal into a voltage signal.